

PolySwitch Resettable Devices

Telecommunications and Networking Devices

The PolySwitch families of telecommunications and networking devices help meet the growing demand for resettable overcurrent protection. These product families help provide protection against damage caused by power cross and power induction surges as defined in ITU, Telcordia GR1089 and UL60950. Available in chip, surface-mount and radial-leaded configurations, TE's PolySwitch devices help improve the reliability of customer premise and network equipment worldwide.

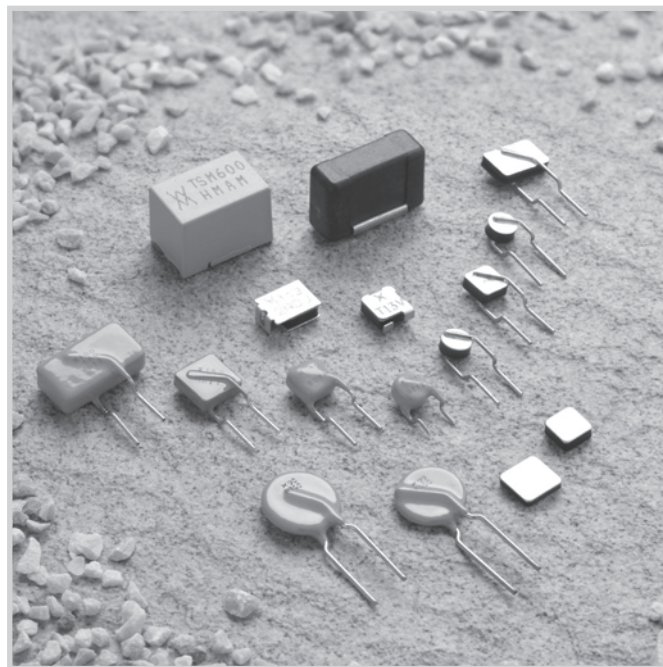

Benefits

- Many product choices give engineers help increase design flexibility
- Compatible with high-volume electronics assembly
- Assist in meeting regulatory equipment requirements
- Help improve line balance
- Applicable for legacy POTS and modern digital communications equipment

Features

- RoHS compliant
- Resettable overcurrent protection
- Surface-mount, radial-leaded and chip form factors
- Fast time-to-trip
- Agency recognition: UL, CSA, TÜV
- Resistance-sorted and matched devices available
- Low parasitic capacitance/flat impedance with frequency

Applications

- | | | |
|----------------------|---------------------------------|---|
| • Modems | • PBX systems | • Powered ethernet systems |
| • Phone sets | • MDF modules | • VoIP (Voice over Internet Protocol) equipment |
| • Fax machines | • Analog and digital line cards | • LAN, WAN equipment |
| • Phone wall outlets | • T1/E1 equipment | • Customer premise equipment |
| • Alarm systems | • xDSL modems and splitters | • Access network hardware |

Application Guide for PolySwitch Telecommunications and Networking Devices*

To use this guide, follow the steps below:

1. Select your equipment type from the guide below.
2. Select the type of protection depending on the agency and regional specifications in the second column.
3. Select the form factor for your application.
4. Use the Agency Specification/ PolySwitch Device Selection Guide on the next page to select a specific part number for each application based on the agency requirements.
5. Parts with fast time-to-trip or low resistance are available. Please consult a TE Circuit Protection representative.

Application	Region/ Specification	Overcurrent Protection		
		Form Factor		
		Radial-leaded	Surface-mount	Chip
Customer Premise equipment IT equipment Analog Modems, V.90 Modems, ISDN Modems, xDSL Modems, ADSL Splitters, Phone Sets, Fax Machines, Answering Machines, Caller ID, Internet Appliances, PBX Systems, POS Terminals, Wall Plugs	North America TIA-968-A, UL 60950, GR1089 Port Type 3 [†]	TRF600-150	TS600-170F	
		TR600-150F-EX	TS600-200F	
		TRF600-160	TSM600-250F	
		TRF600-250	TSM600-400F	
	Europe/Asia/ South America ITU K.21	TRF250-120	TS250-130F	
		TRF250-120T	TSV250-130F	
		TRF250-145	TSV250-184F	
		TRF250-183		
		TRF250-184		
Access network equipment (†) Remote Terminals, Line Repeaters, Multiplexers, Cross-Connects, WAN Equipment	North America GR1089 Port Type 5 [†]	TRF600-160	TS600-170F	
		TRF600-250	TS600-200F	
		TRF600-400	TS600-400F	
			TSM600-250F	
	Europe/Asia/ South America ITU K.45		TSM600-400F	
			FT600-1250**	
		TRF250-120	TS250-130F	
		TRF250-120T	TSV250-130F	
		TRF250-145	TSV250-184F	
		TRF250-183		
Central office switching equipment (†) Analog/POTS Linecards, ISDN Linecards, xDSL Modems, ADSL/VDSL Splitters, T1/E1 Linecards, Multiplexers, CSU/DSU, Servers	North America GR1089 Port Type 1 [†]	TRF600-160	TS600-170F	
		TRF600-250	TS600-200F	
		TRF600-400	TS600-400F	
			TSM600-250F	
	Europe/Asia/ South America ITU K.20		TSM600-400F	
			FT600-1250**	
		TRF250-120	TS250-130F	TCF250-180
		TRF250-120T	TSV250-130F	
		TRF250-145	TSV250-184F	
		TRF250-183		
Primary protection modules (†) MDF modules, Network Interface Devices (NID)	North America Telcordia GR-974	TRF250-183	TSV250-184F	
		TRF250-184		
	Europe/Asia/ South America ITU K.20	TRF250-055UT	TSL250-080F	TCF250-100T
		TRF250-080U	TS250-130F	TCF250-120T
		TRF250-110U	TSV250-130F	TCF250-145T
		TRF250-120	TSV250-184F	TCF250-180
		TRF250-120T		
		TRF250-145		
		TRF250-183		
		TRF250-184		
Short-haul/intrabuilding communications equipment (†) LAN Equipment, VoIP Cards, Cable Telephony NIUs, Wireless Local Loop Handsets	North America GR1089 Port Type 2 [†] GR1089 Port Type 4 [†]	TRF250-080U	TSL250-080F	
		TRF250-120	TS250-130F	
		TRF250-120T	TSV250-130F	
		TRF250-145	TSV250-184F	
	Europe/Asia/ South America ITU K.21	TRF250-183		
		TRF250-184		
		TRF250-120	TS250-130F	
		TRF250-120T	TSV250-130F	
		TRF250-145	TSV250-184F	
		TRF250-183		
TSV250-184				

* Applies to all products which share the same prefix. † Tested with 230V gas discharge tube primary protector.

Application	Region/ Specification	Overcurrent Protection		
		Form Factor		
		Radial-leaded	Surface-mount	Chip
LAN Intra-building Power Cross Protection LAN Equipment, VoIP Cards, IP Phones	North America GR1089 Port Type 4 [†]	TSL250-080U	TSL250-080F	
		TRF250-120	TS250-130F	
		TRF250-120T	TSV250-130F	
		TRF250-145	TSV250-184F	
		TRF250-183		
		TRF250-184		
IEEE 802.3AF/AT Power over Ethernet protection Powered Ethernet Switches and Terminals, IP phones, Wireless LAN Base Stations, Microcellular Base Stations, VoIP Cards			decaSMDC050F/60-2 ^{††}	

* This list is not exhaustive. TE Circuit Protection welcomes our customers' input for additional application ideas for PolySwitch resettable devices.
[†] For improved line balance in these applications, resistance-matched parts are recommended.
[‡] May require additional impedance or coordination with primary protector.
^{**} FT600-1250 are surface-mount telecom fuse devices. FT600-0500 and FT600-2000 reference also available. See telecom fuses section.
^{††} For details on decaSMDC050F/60-2, see surface-mount devices section.

Agency Specification/Selection Guide for Telecommunications and Networking Devices

Use the guide below to select the PolySwitch devices that are typically used in your application. The following pages contain the specifications for the part numbers recommended below. PolySwitch devices assist telecommunication equipment in meeting the applicable protection requirements of these industry specifications. Refer to individual agency specifications for test procedures and circuit schematics. Users should independently evaluate the suitability of and test each product for their application.

Family	Product*	Lightning	Power Cross/Contact/Induction
TCF250	TCF250-100T	ITU K.20 – 1.0kV 10/700 μ s	PRC YD/T694
		GR-1089 Port Types 2 and 4 – 1st Level	ITU K.20/21/45 – 0.2A ² s
			ITU K.20/21/45 – 1A ² s [†]
		GR-1089 Port Type 4 – 120V _{AC} , 25Asc	
	TCF250-120T	ITU K.20/21/45 – 1.5kV 10/700 μ s	ITU K.20/21/45 – 230V _{AC} , 10 Ω
TCF250-145T	ITU K.20/21/45 – 4.0kV 10/700 μ s [†]	ITU K.20/21/45 – 0.2A ² s	
TCF250-180	GR-1089 Port Types 2 and 4 – 1st Level	ITU K.20/21/45 – 1A ² s [†]	
		ITU K.20/21/45 – 10A ² s [†]	
		GR-1089 Port Type 4 – 120V _{AC} , 25Asc	

* Applies to all products which share the same prefix.
[†] Tested with 230V gas discharge tube primary protector.

Family	Product*	Lightning	Power Cross/Contact/Induction
TRF250	TRF250-055UT	ITU K.20 – 1.0kV 10/700µs	ITU K.20 – 230V _{AC} , 10Ω
	TRF250-080U	ITU K.20 – 1.0kV 10/700µs GR-1089 Port Types 2 and 4 – 1st Level	ITU K.20 – 230V _{AC} , 10Ω ITU K.20 – 0.2A ² s ITU K.20 – 1A ² s† GR-1089 Port Type 4 – 120V _{AC} , 25Asc
	TRF250-110U	ITU K.20/21/45 – 1.5kV 10/700µs	ITU K.20/21/45 – 230V _{AC} , 10Ω
	TRF250-120	ITU K.20/21/45 – 4.0kV 10/700µs†	ITU K.20/21/45 – 0.2A ² s
	TRF250-120T	GR-1089 Port Types 2 and 4 – 1st Level	ITU K.20/21/45 – 1A ² s†
	TRF250-120U		ITU K.20/21/45 – 10A ² s†
	TRF250-120UT		GR-1089 Port Type 4 – 120V _{AC} , 25Asc
	TRF250-145		
	TRF250-145U		
	TRF250-183		
	TRF250-184	ITU K.20/21/45 – 1.5kV 10/700µs ITU K.20/21/45 – 4.0kV 10/700µs‡ GR-1089 Port Types 2 and 4 – 1st Level	ITU K.20/21/45 – 230V _{AC} , 10Ω** ITU K.20/21/45 – 0.2A ² s ITU K.20/21/45 – 1A ² s‡ ITU K.20/21/45 – 10A ² s‡ GR-1089 Port Type 4 – 120V _{AC} , 25Asc
TS250/TSV250	TSV250-130F	ITU K.20/21/45 – 1.5kV 10/700µs	ITU K.20/21/45 – 230V _{AC} , 10Ω
	TS250-130F	ITU K.20/21/45 – 4.0kV 10/700µs† GR-1089 Port Types 2 and 4 – 1st Level	ITU K.20/21/45 – 0.2A ² s ITU K.20/21/45 – 1A ² s† ITU K.20/21/45 – 10A ² s† GR-1089 Port Type 4 – 120V _{AC} , 25Asc
	TS250-130F-RB	ITU K.20/21/45 – 1.5kV 10/700µs ITU K.20/21/45 – 4.0kV 10/700µs‡ GR-1089 Port Types 2 and 4 – 1st Level	ITU K.20/21/45 – 230V _{AC} , 10Ω ITU K.20/21/45 – 0.2A ² s ITU K.20/21/45 – 1A ² s‡ ITU K.20/21/45 – 10A ² s‡ GR-1089 Port Type 4 – 120V _{AC} , 25Asc
	TSV250-184F	ITU K.20/21/45 – 1.5kV 10/700µs ITU K.20/21/45 – 4.0kV 10/700µs‡ GR-1089 Port Types 2 and 4 – 1st Level	ITU K.20/21/45 – 230V _{AC} , 10Ω** ITU K.20/21/45 – 0.2A ² s ITU K.20/21/45 – 1A ² s‡ ITU K.20/21/45 – 10A ² s‡ GR-1089 Port Type 4 – 120V _{AC} , 25Asc
TSL250	TSL250-080F	GR-1089 Port Types 2 and 4 – 1st Level ITU K.20 – 1.0kV 10/700µs	GR-1089 Port Type 4 – 120V _{AC} , 25Asc ITU K.20/21/45 – 230V _{AC} , 10Ω ITU K.20/21/45 – 0.2A ² s ITU K.20/21/45 – 1A ² s†
TRF600	TRF600-150	TIA-968-A Types A & B	UL60950 – 600V _{AC} , 40Asc
	TR600-150F-EX	GR-1089 Port Types 1, 3 and 5 – 1st and 2nd Level††	UL60950 – 600V _{AC} , 40Asc
	TR600-150F-EX-RA-B-0.5	GR-1089 Port Types 1, 3 and 5 – 1st and 2nd Level††	UL60950 – 600V _{AC} , 40Asc
	TRF600-160	GR-1089 Port Types 1, 3 and 5 – 1st and 2nd Level††	Telcordia GR-1089 – 600V _{AC} , 60Asc
	TRF600-250	GR-1089 Port Types 1, 3 and 5 – 1st and 2nd Level††	Telcordia GR-1089 – 600V _{AC} , 60Asc
	TRF600-400	GR-1089 Port Types 1, 3 and 5 – 1st and 2nd Level	Telcordia GR-1089 – 600V _{AC} , 60Asc
TS600	TS600-170F	TIA-968-A Types A & B	UL60950 – 600V _{AC} , 40Asc
	TS600-200F-RA	GR-1089 Port Types 1, 3 and 5 – 1st and 2nd Level††	Telcordia GR-1089 – 600V _{AC} , 60Asc
	TS600-400F		
TSM600	TSM600-250F	TIA-968-A Types A & B	UL60950 – 600V _{AC} , 40Asc
	TSM600-250F-RA	GR-1089 Port Types 1, 3 and 5 – 1st and 2nd Level††	Telcordia GR-1089 – 600V _{AC} , 60Asc
	TSM600-400F	TIA-968-A Types A & B GR-1089 Port Types 1, 3 and 5 – 1st and 2nd Level	UL60950 – 600V _{AC} , 40Asc Telcordia GR-1089 – 600V _{AC} , 60Asc
FT600‡‡	FT600-0500	TIA-968-A - Types A & B	UL60950 - 600V _{AC} , 40Asc
	FT600-1250		
	FT600-2000	GR-1089 Port Types 1, 3 and 5 – 1st and 2nd Level	Telcordia GR-1089 – 600V _{AC} , 60Asc

* Applies to all products that share the same prefix.

† Tested with 230V gas discharge tube primary protector.

‡ Tested with 350V gas discharge tube primary protector.

** See SCD for additional application fault ratings.

†† May require additional series resistor to help telecommunication equipment pass Surge 3 (1kV, 10/1000µs).

‡‡ See telecom fuses section.

Table T1 Product Series: Size, Current Rating, Voltage Rating, Typical Resistance for PolySwitch Telecommunications and Networking Devices

	TCF250	TRF250	TS250	TSV250	TSL250	TS600 TSM600	TRF600
V_{MAX} Interrupt (V_{AC})*	250	250	250	250	250	600	600
Specification	ITU GR-1089 Ports 2 and 4	ITU GR-1089 Ports 2 and 4	ITU GR-1089 Ports 2 and 4	ITU GR-1089 Ports 2 and 4	GR-1089 Ports 2 and 4	UL60950 GR-1089 Ports 1, 3 and 5	UL60950 GR-1089 Ports 1, 3 and 5
Hold Current (A)							
0.055	—	20.0Ω	—	—	—	—	—
0.080	—	17.0Ω	—	—	8.0Ω	—	—
0.100	11.0Ω	—	—	—	—	—	—
0.110	—	7.0Ω	—	—	—	—	—
0.120	10.5Ω	8.0Ω	—	—	—	—	—
0.130	—	—	9.0Ω	5.5Ω	—	—	—
0.145	7.0Ω	4.5Ω	—	—	—	—	—
0.150	—	—	—	—	—	—	8.0Ω
0.160	—	—	—	—	—	—	6.0Ω
0.170	—	—	—	—	—	11.0Ω	—
0.183	—	1.3Ω	—	—	—	—	—
0.184	—	1.9Ω	—	1.6Ω	—	—	—
0.200	—	—	—	—	—	8.5Ω	—
0.250	—	—	—	—	—	3.5Ω	3.0Ω
0.400	—	—	—	—	—	1.2Ω	1.2Ω

Voltage Ratings for Telecommunications and Networking Devices

For circuit protection telecommunications devices there are two applicable voltage ratings. These are V_{MAX} Operating and V_{MAX} Interrupt. To help understand the nature of these two different voltage ratings, the following definitions are provided:

V_{MAX} Operating: For telecommunications devices, this is the voltage used to obtain component recognition under UL1434. Most circuit protection devices are certified at 60V but can withstand higher V_{MAX} Interrupt conditions. See Table T3 for its V_{MAX} Operating.

***V_{MAX} Interrupt:** Under specified conditions, this is the highest voltage that can be applied to the device at the maximum current. Devices may trip safely under higher power level cross conditions, as listed above, to assist equipment in meeting the appropriate industry conditions.

Table T2 Thermal Derating for PolySwitch Telecommunications and Networking Devices [Hold Current (A) at Ambient Temperature (°C)]

Part Number	Maximum Ambient Temperature								
	-40°C	-20°C	0°C	20°C	40°C	50°C	60°C	70°C	85°C
Chip* — 250V_{AC}									
TCF250									
TCF250-100T	0.155	0.138	0.119	0.100	0.083	0.073	0.064	0.055	0.042
TCF250-120T	0.186	0.165	0.143	0.120	0.099	0.088	0.077	0.066	0.050
TCF250-145T	0.225	0.199	0.172	0.145	0.119	0.106	0.093	0.080	0.060
TCF250-180†	0.269	0.240	0.211	0.180	0.153	0.138	0.123	0.109	0.087
Radial-led* — 250V_{AC}									
TRF250									
TRF250-055UT	0.085	0.076	0.065	0.055	0.045	0.041	0.035	0.030	0.023
TRF250-080U	0.124	0.110	0.095	0.080	0.066	0.059	0.051	0.044	0.033
TRF250-110U	0.171	0.151	0.131	0.110	0.091	0.081	0.071	0.061	0.046
TRF250-120	0.186	0.165	0.143	0.120	0.099	0.088	0.077	0.066	0.050
TRF250-145	0.225	0.199	0.172	0.145	0.119	0.106	0.093	0.080	0.060
TRF250-183‡	0.284	0.251	0.217	0.183	0.149	0.133	0.117	0.101	0.075
TRF250-184‡	0.286	0.252	0.218	0.184	0.150	0.134	0.118	0.102	0.075
Surface-mount* — 250V_{AC}									
TS250/TSL250/TSV250									
TSL250-080F	0.124	0.110	0.095	0.080	0.066	0.059	0.051	0.044	0.033
TS250-130F	0.208	0.182	0.156	0.130	0.104	0.091	0.078	0.065	0.045
TSV250-130F	0.208	0.182	0.156	0.130	0.104	0.091	0.078	0.065	0.045
TSV250-184F	0.286	0.252	0.218	0.184	0.150	0.134	0.118	0.102	0.075
Radial-led† — 600V_{AC}									
TRF600									
TRF600-150	0.239	0.209	0.180	0.150	0.121	0.107	0.093	0.079	0.057
TR600-150F-EX	0.239	0.209	0.180	0.150	0.121	0.107	0.093	0.079	0.057
TR600-150F-EX-RA	0.239	0.209	0.180	0.150	0.121	0.107	0.093	0.079	0.057
TRF600-160	0.255	0.223	0.192	0.160	0.129	0.114	0.099	0.084	0.061
TRF600-250	0.400	0.350	0.300	0.250	0.198	0.170	0.140	0.117	0.083
TRF600-400	0.640	0.560	0.480	0.400	0.320	0.270	0.230	0.190	0.130
Surface-mount† — 600V_{AC}									
TSM600/TSM600									
TS600-170F	0.264	0.230	0.200	0.170	0.140	0.125	0.109	0.094	0.070
TS600-200F-RA-B-0.5	0.310	0.275	0.238	0.200	0.165	0.147	0.128	0.110	0.083
TS600-400F	0.640	0.560	0.480	0.400	0.320	0.270	0.230	0.190	0.130
TSM600-250F	0.400	0.350	0.300	0.250	0.198	0.170	0.140	0.117	0.083
TSM600-250F-RA	0.400	0.350	0.300	0.250	0.198	0.170	0.140	0.117	0.083
TSM600-400F	0.640	0.560	0.480	0.400	0.320	0.270	0.230	0.190	0.130

* 250V_{AC} interrupt products may help equipment pass ITU K.20, K.21 and K.45 recommendations and Telcordia GR-1089 Port Type 2 and 4 requirements.

† 600V_{AC} interrupt products may help equipment pass UL60950, TIA-968-A and GR1089 Port Type 1, 3 and 5 requirements.

‡ Product is not currently available in a resistance matched or sorted option.

Figure T1 Thermal Derating [Hold Current (A) at Ambient Temperature (°C)]

- A = TCF250-180
- B = All other TCF, TRF, TSM Series Devices

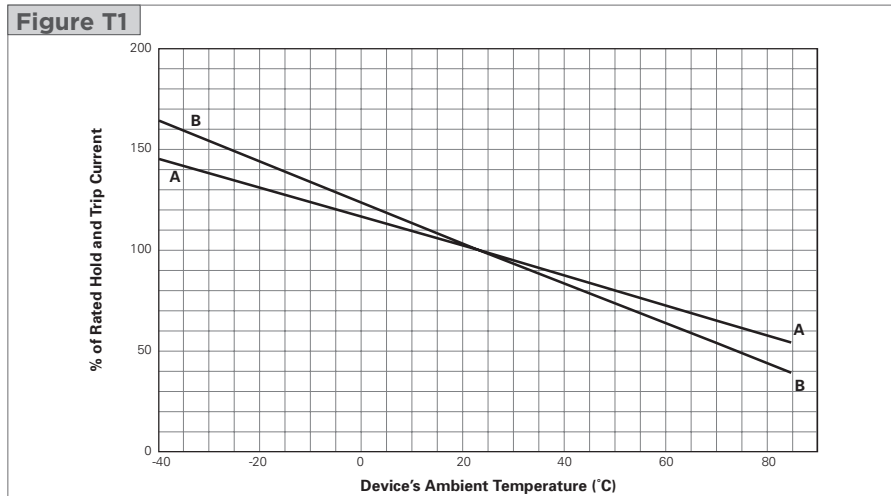

Table T3 Electrical Characteristics for PolySwitch Telecommunications and Networking Devices

Part Number	I _H (A)	I _T (A)	V _{MAX}		I _{MAX} *† (A)	P _D TYP (W)	Typical Time-to-trip		R _{MIN} (Ω)	R _{MAX} (Ω)	R _{1MAX} (Ω)
			Operating (V _{DC})	Interrupt (V _{RMS})			(A)	(s)			
Chip* — 250V_{AC}											
TCF250											
TCF250-100T	0.100	0.150	60	250	3.0	0.6	1.0	0.2	14.0	18.0	24.0
TCF250-120T	0.120	0.240	60	250	3.0	1.0	1.0	0.6	6.3	12.0	18.0
TCF250-145T	0.145	0.290	60	250	3.0	1.0	1.0	1.5	5.0	9.0	14.0
TCF250-180†	0.180	0.650	60	250	3.0	0.9	1.0	15.5	1.0	2.2	4.0
Radial-led* — 250V_{AC}											
TRF250											
TRF250-055UT	0.055	0.170	60	250	3.0	0.6	0.28	3.0	15.0	25.0	35.0
TRF250-080T	0.080	0.160	60	250	3.0	0.6	0.35	2.5	15.0	22.0	33.0
TRF250-080U	0.080	0.160	60	250	3.0	0.6	0.35	2.5	14.0	20.0	33.0
TRF250-110U	0.110	0.220	60	250	3.0	1.0	1.00	0.8	5.0	9.0	16.0
TRF250-120	0.120	0.240	60	250	3.0	1.0	1.00	1.5	4.0	8.0	16.0
TRF250-120T	0.120	0.240	60	250	3.0	1.0	0.35	0.7	7.0	12.0	16.0
TRF250-120T-RA	0.120	0.240	60	250	3.0	1.0	1.00	1.2	7.0	9.0	16.0
TRF250-120T-RC	0.130	0.260	60	250	3.0	1.0	1.00	1.5	5.4	7.5	14.0
TRF250-120T-RF	0.120	0.240	60	250	3.0	1.0	1.00	0.9	6.0	10.5	16.0
TRF250-120T-R1	0.120	0.240	60	250	3.0	1.0	1.00	1.0	6.0	9.0	16.0
TRF250-120T-R2	0.120	0.240	60	250	3.0	1.0	1.00	0.8	8.0	10.5	16.0
TRF250-120U	0.120	0.240	60	250	3.0	1.0	1.00	1.0	6.0	10.0	16.0
TRF250-120UT	0.120	0.240	60	250	3.0	1.0	1.00	0.7	7.0	12.0	16.0
TRF250-145	0.145	0.290	60	250	3.0	1.0	1.00	2.5	3.0	6.0	14.0
TRF250-145-RA	0.145	0.290	60	250	3.0	1.0	1.00	2.5	3.0	5.5	12.0
TRF250-145-RB	0.145	0.290	60	250	3.0	1.0	1.00	2.0	4.5	6.0	14.0
TRF250-145T	0.145	0.290	60	250	3.0	1.0	1.00	1.5	5.4	7.5	14.0
TRF250-145U	0.145	0.290	60	250	3.0	1.0	1.00	2.0	3.5	6.5	14.0
TRF250-183†	0.183	0.685	100	250	10.0	0.9	3.00	0.6	0.8	2.2	3.4
TRF250-184†	0.184	1.000	100	250	10.0	0.9	3.00	0.5	1.2	2.4	3.1
Surface-mount* — 250V_{AC}											
TS250/TSL250/TSV250											
TSL250-080F	0.080	0.240	80	250	3.0	1.2	1.0	0.8	5.0	11.0	20.0**
TS250-130F	0.130	0.260	60	250	3.0	1.1	1.0	0.9	6.5	12.0	20.0**
	—	—	60	600	1.0	—	—	—	—	—	—
TS250-130F-RA	0.130	0.260	60	250	3.0	1.1	1.0	1.4	6.5	9.0	15.0**
	—	—	60	600	1.0	—	—	—	—	—	—
TS250-130F-RB	0.130	0.260	60	250	3.0	1.1	1.0	0.7	9.0	12.0	20.0**
	—	—	60	600	1.0	—	—	—	—	—	—
TS250-130F-RC	0.130	0.260	60	250	3.0	1.1	1.0	1.1	7.0	10.0	17.0**
	—	—	60	600	1.0	—	—	—	—	—	—
TSV250-130F	0.130	0.260	60	250	3.0	1.5	1.0	2.0	4.0	7.0	12.0**
TSV250-184F	0.184	0.690	100	250	10.0	0.9	3.0	0.5	1.2	3.0	4.0**
Radial-led† — 600V_{AC}											
TRF600											
TRF600-150	0.150	0.300	250	600	3.0	1.4	1.0	1.4	6.0	10.0	17.0
TRF600-150-RB	0.130	0.260	250	600	3.0	1.0	1.0	1.0	9.0	12.0	22.0
TR600-150F-EX	0.150	0.300	250	600	3.0	1.4	1.0	5.0	6.0	12.0	22.0
TR600-150F-EX-RA-B-0.5	0.150	0.300	250	600	3.0	1.4	1.0	5.0	7.0	10.0	20.0
TRF600-160	0.160	0.320	250	600	3.0	1.7	1.0	7.5	4.0	10.0	18.0
TRF600-160-RA	0.160	0.320	250	600	3.0	1.7	1.0	9.5	4.0	7.0	16.0
TRF600-160-R1	0.160	0.320	250	600	3.0	1.7	1.0	9.0	4.0	8.0	17.0
TRF600-250	0.250	0.850	250	600	3.0	2.0	3.0	1.0	1.0	4.3	7.0
TRF600-400	0.400	1.000	60	600	3.0	2.4	3.0	4.0	0.95	1.45	1.90

 * 250V_{AC} interrupt products may help equipment pass ITU K.20, K.21 and K.45 recommendations and Telcordia GR-1089 Port Type 2 and 4 requirements.

 † 600V_{AC} interrupt products may help equipment pass UL60950, TIA-968-A and GR1089 Port Type 1, 3 and 5 requirements.

‡ Product is not currently available in a resistance matched or sorted option.

 ** R_{1MAX} measured 1 hour post-trip or 24 hours post-reflow at 20°C.

Table T3 Electrical Characteristics for PolySwitch Telecommunications and Networking Devices Cont'd

Part Number	I_H (A)	I_T (A)	V_{MAX}		$I_{MAX}^{*†}$ (A)	P_D Typ (W)	Typical Time-to-trip		R_{MIN} (Ω)	R_{MAX} (Ω)	R_{1MAX} (Ω)
			Operating (V_{DC})	Interrupt (V_{RMS})			(A)	(s)			
Surface-mount† — 600V_{AC}											
TS600/TSM600											
TS600-170F	0.170	0.400	60	600	3.0	2.5	1.0	10.0	4.0	9.0	18.0
TS600-200F-RA-B-0.5	0.200	0.400	60	600	3.0	2.5	1.0	12.0	4.0	7.5	13.5
TS600-400F	0.400	1.000	60	600	3.0	2.0	3.0	5.0	0.5	1.5	2.0
TSM600-250F	0.250	0.860	250	600	3.0	2.0	3.0	0.8	1.0	3.5	7.0
TSM600-250F-RA	0.250	0.860	250	600	3.0	2.0	3.0	1.0	1.0	3.0	5.0
TSM600-400F	0.400	1.000	250	600	3.0	2.0	3.0	5.0	0.5	1.5	2.0

Notes:

- I_H : Hold current: maximum current device will pass without interruption in 20°C still air.
- I_T : Trip current: minimum current that will switch the device from low resistance to high resistance in 20°C still air.
- V_{MAX} Operating : Maximum continuous voltage device can withstand without damage at rated current. This voltage is used for component recognition under UL1434.
- V_{MAX} Interrupt : Maximum voltage that can be safely placed across a device in its tripped state. Devices may trip safely under higher level power cross conditions to assist equipment in meeting the appropriate ITU, UL60950 or GR1089 industry requirements.
- I_{MAX} Interrupt : Maximum fault current device can withstand without damage at rated operating voltage. This current is used for component recognition under UL1434. Devices may trip safely under higher level power cross conditions to assist equipment in meeting the appropriate ITU, UL60950 or GR1089 industry requirements.
- P_D : Power dissipated from device when in the tripped state in 20°C still air.
- R_{MIN} : Minimum resistance of device as supplied at 20°C unless otherwise specified.
- R_{MAX} : Maximum resistance of device as supplied at 20°C unless otherwise specified.
- R_{1MAX} : Maximum resistance measured one hour post-trip or post-reflow at 20°C.

* 250V_{AC} interrupt products may help equipment pass ITU K.20, K.21 and K.45 recommendations and Telcordia GR-1089 Port Type 2 and 4 requirements.

† 600V_{AC} interrupt products may help equipment pass UL60950, TIA-968-A and GR1089 Port Type 1, 3 and 5 requirements.

Figures T2-T13 Dimension Figures for PolySwitch Telecommunications and Networking Devices
Figure T2

Figure T3

Figure T4

Figure T5

Figure T6

Figure T7

Figures T2-T13 Dimension Figures for PolySwitch Telecommunications and Networking Devices Cont'd

Figure T8



Figure T9



Figure T10



Figure T11



Figure T12

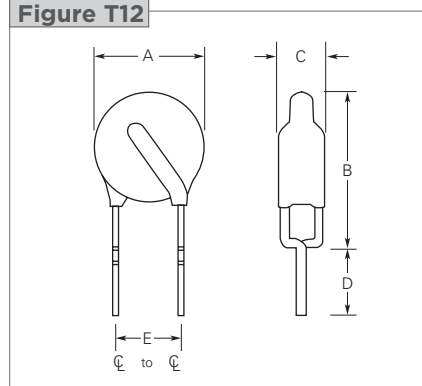

Figure T13



Table T4 Dimensions & Weights for PolySwitch Telecommunications and Networking Devices

Part Number	Dimensions in Millimeters (Inches)														Figure	Device Mass (g) (Only for Reference)
	A		B		C		D		E		F		G			
	Min	Max	Min	Max	Min	Max	Min	Max	Min	Max	Min	Max	Min	Max		
TCF-250V*																
TCF250-100T	4.6 (0.18)	4.9 (0.19)	4.6 (0.18)	4.9 (0.19)	2.0 (0.08)	2.3 (0.09)	—	—	—	—	—	—	—	—	T4	0.24
TCF250-120T	5.4 (0.21)	5.6 (0.22)	5.4 (0.21)	5.6 (0.22)	2.0 (0.08)	2.3 (0.09)	—	—	—	—	—	—	—	—	T4	0.28
TCF250-145T	5.4 (0.21)	5.6 (0.22)	5.4 (0.21)	5.6 (0.22)	2.0 (0.08)	2.5 (0.10)	—	—	—	—	—	—	—	—	T4	0.28
TCF250-180	6.9 (0.27)	7.1 (0.28)	6.9 (0.27)	7.1 (0.28)	1.3 (0.05)	1.6 (0.06)	—	—	—	—	—	—	—	—	T4	0.35
TRF250-250V*																
TRF250-055UT	—	4.8 (0.19)	—	9.3 (0.37)	—	3.8 (0.15)	4.7 (0.19)	—	5.0 [†] (0.20)	—	—	—	—	—	T2	0.13
TRF250-080T	—	5.8 (0.23)	—	9.9 (0.39)	—	4.6 (0.18)	4.7 (0.19)	—	5.0 [†] (0.20)	—	—	—	—	—	T2	0.28
TRF250-080U	—	4.8 (0.19)	—	9.3 (0.37)	—	3.8 (0.15)	4.7 (0.19)	—	5.0 [†] (0.20)	—	—	—	—	—	T11	0.13
TRF250-110U	—	5.3 (0.21)	—	9.4 (0.37)	—	3.8 (0.15)	4.7 (0.19)	—	5.0 [†] (0.20)	—	—	—	—	—	T11	0.13
TRF250-120	—	6.5 (0.26)	—	11.0 (0.43)	—	4.6 (0.18)	4.7 (0.19)	—	5.0 [†] (0.20)	—	—	—	—	—	T3	0.38
TRF250-120U	—	6.0 (0.24)	—	10.0 (0.39)	—	3.8 (0.15)	4.7 (0.19)	—	5.0 [†] (0.20)	—	—	—	—	—	T10	0.19
TRF250-145	—	6.5 (0.26)	—	11.0 (0.43)	—	4.6 (0.18)	4.7 (0.19)	—	5.0 [†] (0.20)	—	—	—	—	—	T3	0.38
TRF250-145U	—	6.0 (0.24)	—	10.0 (0.39)	—	3.8 (0.15)	4.7 (0.19)	—	5.0 [†] (0.20)	—	—	—	—	—	T10	0.19
TRF250-183	—	7.5 (0.29)	—	10.5 (0.41)	—	4.1 (0.16)	4.7 (0.19)	—	5.0 [†] (0.20)	—	—	—	—	—	T2	0.30
TRF250-184	—	7.7 (0.30)	—	10.5 (0.41)	—	4.6 (0.18)	4.7 (0.19)	—	5.0 [†] (0.20)	—	—	—	—	—	T12	0.32
TS250/TSL250/TSV250-250V*																
TSL250-080F	6.7 (0.27)	7.9 (0.31)	2.7 (0.11)	3.7 (0.15)	4.8 (0.19)	5.3 (0.21)	0.2 (0.01)	0.4 (0.02)	2.5 (0.10)	3.1 (0.12)	—	—	—	—	T7	2.80
TS250-130F	8.5 (0.34)	9.4 (0.37)	—	3.4 (0.14)	—	7.4 (0.29)	0.3 [‡] (0.01)	—	3.8 [‡] (0.15)	—	—	—	—	—	T5	3.60
TSV250-130F	—	6.10 (0.24)	—	6.90 (0.27)	—	3.20 (0.13)	0.56 (0.02)	—	—	1.90 (0.08)	1.60 (0.07)	2.30 (0.09)	—	—	T6	2.80
TSV250-184F	—	6.10 (0.24)	—	6.90 (0.27)	—	3.20 (0.13)	0.56 (0.02)	—	—	1.90 (0.08)	1.60 (0.07)	2.30 (0.09)	—	—	T6	2.80
TRF600-600V[†]																
TRF600-150	—	9.0 (0.35)	—	12.5 (0.49)	—	4.6 (0.18)	4.7 (0.19)	—	5.0 (0.20)	—	—	9.0 (0.35)	—	—	T3	0.37
TR600-150F-EX	—	13.5 (0.53)	—	12.6 (0.50)	—	6.0 (0.18)	4.7 (0.19)	—	5.0 (0.20)	—	—	—	—	—	T3	0.80
TR600-150F-EX-RA-B-0.5	—	13.5 (0.53)	—	12.6 (0.50)	—	6.0 (0.18)	4.7 (0.19)	—	5.0 (0.20)	—	—	—	—	—	T3	0.80
TRF600-160	—	16.0 (0.63)	—	12.6 (0.50)	—	6.0 (0.24)	4.7 (0.19)	—	5.0 [†] (0.20)	—	—	10.0 (0.39)	—	—	T13	0.90
TRF600-250	—	15.0 (0.59)	—	14.5 (0.57)	—	4.6 (0.18)	4.7 (0.19)	—	5.0 [†] (0.20)	—	—	10.0 (0.39)	—	—	T3	0.87
TRF600-400	—	14.8 (0.58)	—	13.1 (0.52)	—	4.6 (0.18)	4.7 (0.19)	—	5.0 [†] (0.20)	—	—	—	—	—	T13	0.85

* 250V_{AC} interrupt products may help equipment pass ITU K.20, K.21 and K.45 recommendations and Telcordia GR-1089 Port Type 2 and 4 requirements.

† 600V_{AC} interrupt products may help equipment pass UL60950, TIA-968-A and GR1089 Port Type 1, 3 and 5 requirements.

‡ Indicates dimension is typical, not minimum.

Table T4 Dimensions & Weights for PolySwitch Telecommunications and Networking Devices Cont'd

Part Number	Dimensions in Millimeters (Inches)														Figure	Device Mass (g) (Only for Reference)
	A		B		C		D		E		F		G			
	Min	Max	Min	Max	Min	Max	Min	Max	Min	Max	Min	Max	Min	Max		
TS600/TSM600-600V†																
TS600-170F	18.3 (0.72)	19.4 (0.77)	11.6 (0.46)	12.3 (0.49)	7.2 (0.29)	8.3 (0.33)	1.7 (0.07)	2.4 (0.10)	9.9 (0.39)	10.4 (0.41)	1.5 (0.06)	2.3 (0.09)	—	—	T8	23.6
TS600-200F-RA	18.3 (0.72)	19.4 (0.77)	11.6 (0.46)	12.3 (0.49)	7.2 (0.29)	8.3 (0.33)	1.7 (0.07)	2.4 (0.10)	9.9 (0.39)	10.4 (0.41)	1.5 (0.06)	2.3 (0.09)	—	—	T8	23.6
TS600-400F	18.3 (0.72)	19.4 (0.77)	11.6 (0.46)	12.3 (0.49)	7.2 (0.29)	8.3 (0.33)	1.7 (0.07)	2.4 (0.10)	9.9 (0.39)	10.4 (0.41)	1.5 (0.06)	2.3 (0.09)	—	—	T8	19.8
TSM600-250F	17.0 (0.67)	17.60 (0.69)	11.20 (0.44)	11.70 (0.46)	10.40 (0.41)	11.20 (0.44)	4.80 (0.19)	5.20 (0.20)	2.50 (0.10)	2.80 (0.11)	0.60 (0.02)	1.0 (0.04)	2.2 (0.09)	3.1 (0.12)	T9	31.2
TSM600-250F-RA	17.0 (0.67)	17.60 (0.69)	11.20 (0.44)	11.70 (0.46)	10.40 (0.41)	11.20 (0.44)	4.80 (0.19)	5.20 (0.20)	2.50 (0.10)	2.80 (0.11)	0.60 (0.02)	1.0 (0.04)	2.2 (0.09)	3.1 (0.12)	T9	31.2
TSM600-400F	17.0 (0.67)	17.60 (0.69)	11.20 (0.44)	11.70 (0.46)	10.40 (0.41)	11.20 (0.44)	4.80 (0.19)	5.20 (0.20)	2.50 (0.10)	2.80 (0.11)	0.60 (0.02)	1.0 (0.04)	2.2 (0.09)	3.1 (0.12)	T9	31.2

 † 600V_{AC} interrupt products may help equipment pass UL60950, TIA-968-A and GR1089 Port Type 1, 3 and 5 requirements.

TCF250

- A = TCF250-180
- B = TCF250-145T
- C = TCF250-120T
- D = TCF250-100T

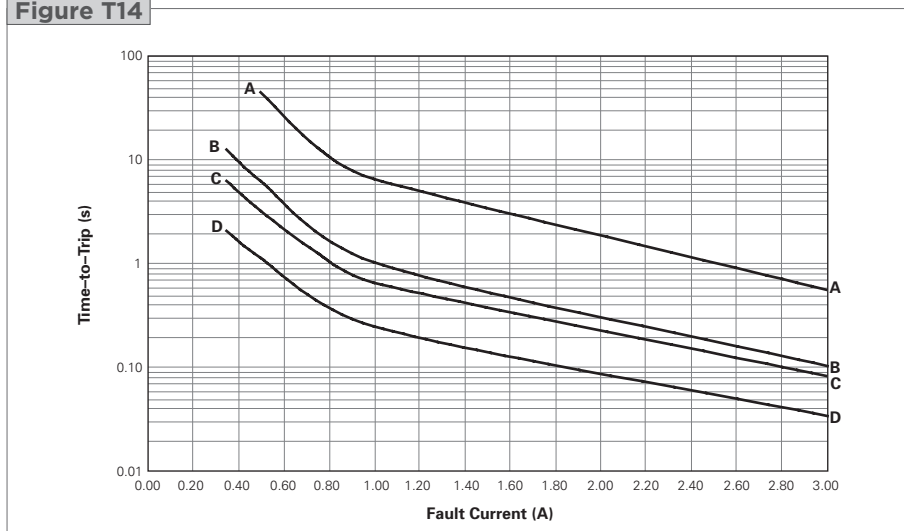
Figure T14

TRF250

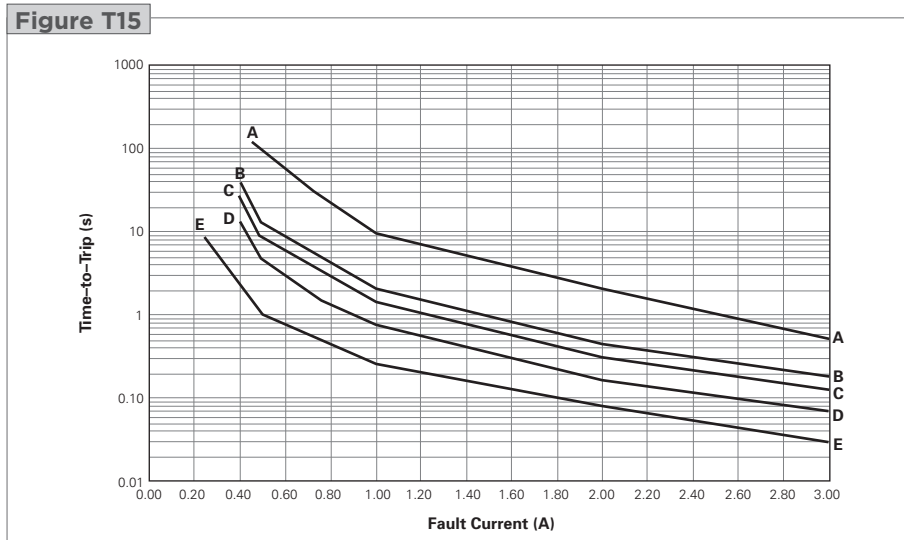
- A = TRF250-180/183/184
- B = TRF250-145/145U
- C = TRF250-120/120U
- D = TRF250-110U/120UT/120T
- E = TRF250-080T/080U/080US

Figure T15

TS250/TSV250/TSL250

- A = TSV250-184F
- B = TSV250-130F
- C = TS250-130F
- D = TSL250-080F

Figure T16

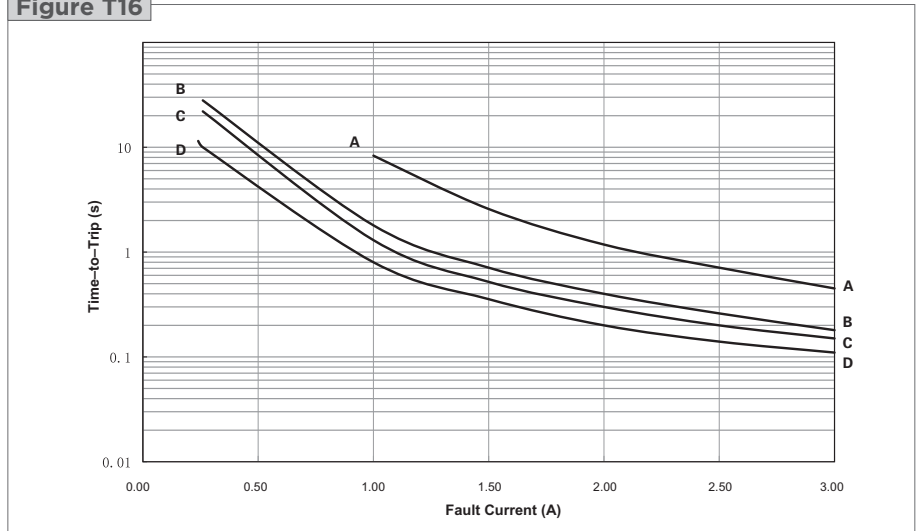

TRF600/TS600/TSM600

- A = TRF600-400/TS600-400/
TSM600-400F
- B = TRF600-250/TSM600-250F/
TS600-170F/200F
- C = TRF600-160
- D = TR600-150F-EX
- E = TRF600-150

Figure T17

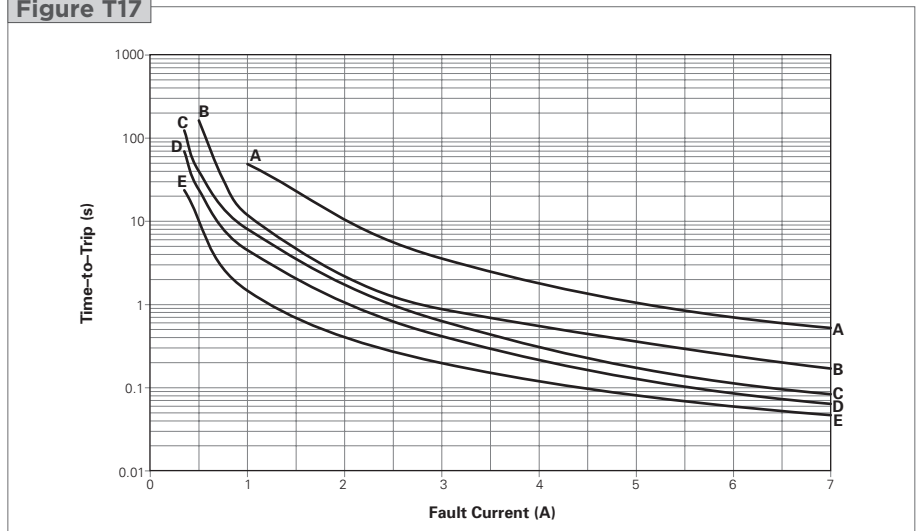

Table T5 Physical Characteristics and Environmental Specifications for PolySwitch Telecommunications and Networking Devices

Operating temperature range for all listed products is -40°C to 85°C, except for TRF250-080T and TRF250-184 (0°C to 85°C)

TCF250*

Physical Characteristics

Terminal Material Nickel-plated Copper Foil

Environmental Specifications

Test	Conditions
Passive Aging	60°C, 1000 hrs 85°C, 1000 hrs
Humidity Aging	85°C, 85% RH, 1000 hrs
Thermal Shock	125°C, -55°C (10 Times)
Solvent Resistance	MIL-STD-202, Method 215F

Note: Storage conditions: 40°C (max), 70% RH (max), devices should remain in original sealed bag prior to use. Devices may not meet specified values if these storage conditions are exceeded.

Table T5 Physical Characteristics and Environmental Specifications for PolySwitch Telecommunications and Networking Devices

Cont'd

Operating temperature range for all listed products is -40°C to 85°C, except for TRF250-080T and TRF250-184 (0°C to 85°C)
TRF250*
Physical Characteristics

Lead Material	Tin-plated Copper, 22AWG
Insulating Material	Cured Epoxy Polymer
Flammability	Per IEC 695-2-2 Needle Flame Test for 20 s
Soldering Characteristics	ANSI/J-STD-002, Category 3
Solder Heat Withstand	IEC-STD 68-2-20, Test Tb, Section 5 Method 1A, Condition B: Can Withstand 10s at 260°C±5°C

Note: Devices are not intended to be placed through a reflow process.

Environmental Specifications

Test	Conditions
Passive Aging	60°C, 1000 hrs
	85°C, 1000 hrs
Humidity Aging	85°C, 85% RH, 1000 hrs
Thermal Shock	125°C, -55°C (10 Times)
Solvent Resistance	MIL-STD-202, Method 215F

Note: Storage conditions: 40°C (max), 70% RH (max), devices should remain in original sealed bag prior to use. Devices may not meet specified values if these storage conditions are exceeded.

TS250/TSV250/TSL250*
Physical Characteristics

Terminal Material	Tin-plated Brass, Nickel Under-plating
Soldering Characteristics	EIC 60008-2-58

Environmental Specifications

Test	Conditions
Passive Aging	60°C, 1000 hrs
	85°C, 1000 hrs
Humidity Aging	85°C, 85% RH, 500 hrs
Thermal Shock	125°C, -55°C (10 Times)
Solvent Resistance	MIL-STD-202, Method 215F

Note: Storage conditions: 40°C (max), 70% RH (max), devices should remain in original sealed bag prior to use. Devices may not meet specified values if these storage conditions are exceeded.

TRF600†
Physical Characteristics

Lead Material	Tin-plated Copper, 22AWG
Insulating Material	Cured Epoxy Polymer [‡]
Flammability	Per IEC 695-2-2 Needle Flame Test for 20s
Soldering Characteristics	ANSI/J-STD-002, Category 3
Solder Heat Withstand	IEC-STD 68-2-20, Test Tb, Section 5 Method 1A, Condition B: Can Withstand 10 s at 260°C±5°C

Note: Devices are not intended to be placed through a reflow process.

Environmental Specifications

Test	Conditions
Passive Aging	60°C, 1000 hrs
	85°C, 1000 hrs
Humidity Aging	85°C, 85% RH, 1000 hrs [‡]
Thermal Shock	125°C, -55°C (10 Times)
Solvent Resistance	MIL-STD-202, Method 215F

Note: Storage conditions: 40°C (max), 70% RH (max) devices should remain in original sealed bag prior to use. Devices may not meet specified values if these storage conditions are exceeded.

 * 250V_{AC} interrupt products may help equipment pass ITU K.20, K.21 and K.45 recommendations and Telcordia GR-1089 Port Type 2 and 4 requirements.

 † 600V_{AC} interrupt products may help equipment pass UL60950, TIA-968-A and GR1089 Port Type 1, 3 and 5 requirements.

‡ Excluding TRF600-150 and TRF600-400, which have a coating that is not rated for dielectric withstand and can withstand 500h at 85°C/85% RH or 1000h at 60°C/90% RH.

Table T5 Physical Characteristics and Environmental Specifications for PolySwitch Telecommunications and Networking Devices

Cont'd

Operating temperature range for all listed products is -40°C to 85°C, except for TRF250-080T and TRF250-184 (0°C to 85°C)

TS600[†]

Physical Characteristics

Terminal Material	Tin-plated Brass
Insulating Material	Nylon Resin (UL94V-0), 1000V Dielectric Rating
Flammability	IEC 695-2-2 Needle Flame Test for 20 s
Soldering Characteristics	ANSI/J-STD-002, Category 3
Solder Heat Withstand	IEC-STD 68-2-20, Test Tb, Section 5 Method 1A

Environmental Specifications

Test	Conditions
Passive Aging	60°C, 1000 hrs
	85°C, 1000 hrs
Humidity Aging	85°C, 85% RH, 1000 hrs
Thermal Shock	125°C, -55°C (10 Times)
Solvent Resistance	MIL-STD-202, Method 215F

Note: Storage conditions: 40°C (max), 70% RH (max), devices should remain in original sealed bag prior to use. Devices may not meet specified values if these storage conditions are exceeded.

TSM600[†]

Physical Characteristics

Terminal Material	Tin-plated Brass
Insulating Material	Nylon Resin (UL94V-0), 1000V Dielectric Rating
Flammability	IEC 695-2-2 Needle Flame Test for 20 s
Soldering Characteristics	EIC60068-2-58, Method 7
Solder Heat Withstand	IEC-STD 68-2-20, Test Tb, Section 5 Method 1A

Environmental Specifications

Test	Conditions
Passive Aging	60°C, 1000 hrs
	85°C, 1000 hrs
Humidity Aging	85°C, 85% RH, 1000 hrs
Storage Humidity	Per IPC/JEDEC J-STD-020A Level 2a
Thermal Shock	125°C, -55°C (10 Times)
Solvent Resistance	MIL-STD-202, Method 215J

Note: Storage conditions: 40°C (max), 70% RH (max) devices should remain in original sealed bag prior to use. Devices may not meet specified values if these storage conditions are exceeded.

[†] 600V_{AC} interrupt products may help equipment pass UL60950, TIA-968-A and GR1089 Port Type 1, 3 and 5 requirements.

Table T6 Packaging and Marking Information for PolySwitch Telecommunications and Networking Devices

Part Number	Bag Quantity	Tape and Reel Quantity	Standard Package Quantity	Part Marking	Agency Recognition
Chip* — 250V_{AC}					
TCF250					
TCF250-100T	2,500	—	10,000	—	—
TCF250-120T	2,500	—	10,000	—	—
TCF250-145T	2,500	—	10,000	—	—
TCF250-180	2,500	—	10,000	—	UL
Radial-leaded* — 250V_{AC}					
TRF250					
TRF250-055UT	500	—	10,000	—	—
TRF250-080U	500	—	10,000	—	UL, CSA, TÜV
TRF250-080U-2	—	1,500	7,500	—	UL, CSA, TÜV
TRF250-080T	500	—	10,000	08F	UL, CSA, TÜV
TRF250-110U	500	—	10,000	—	UL, CSA, TÜV
TRF250-120	500	—	10,000	20F	UL, CSA, TÜV
TRF250-120-2	—	1,500	7,500	20F	UL, CSA, TÜV
TRF250-120T	500	—	10,000	20F	UL, CSA, TÜV
TRF250-120T-2	—	1,500	7,500	20F	UL, CSA, TÜV
TRF250-120U	500	—	10,000	20F	UL, CSA, TÜV
TRF250-120U-2	—	1,500	7,500	20F	UL, CSA, TÜV
TRF250-120UT	500	—	10,000	20F	UL, CSA, TÜV
TRF250-145	500	—	10,000	45F	UL, CSA, TÜV
TRF250-145-2	—	1,500	7,500	45F	UL, CSA, TÜV
TRF250-145-RA	500	—	10,000	45F	UL, CSA, TÜV
TRF250-145U	500	—	10,000	45F	UL, CSA, TÜV
TRF250-145U-2	—	1,500	7,500	45F	UL, CSA, TÜV
TRF250-183	500	—	10,000	83F	UL, CSA, TÜV
TRF250-183-2	—	1,500	7,500	83F	UL, CSA, TÜV
TRF250-184	500	—	10,000	84F	UL, CSA, TÜV
Surface-mount* — 250V_{AC}					
TS250/TSL250/TSV250					
TSL250-080F-2	—	1,500	7,500	T08	UL, CSA, TÜV
TS250-130F-2	—	1,500	7,500	T13	UL, CSA, TÜV
TSV250-130F-2	—	1,200	6,000	T13V	UL, CSA, TÜV
TSV250-184F	2500	—	10,000	T18V	UL
Radial-leaded† — 600V_{AC}					
TRF600					
TRF600-150	500	—	10,000	150F	UL, CSA, TÜV
TRF600-150-2	—	1,500	7,500	150F	UL, CSA, TÜV
TR600-150F-EX	500	—	10,000	150F	UL, CSA
TR600-150F-EX-2	—	600	3,000	150F	UL, CSA
TR600-150F-EX-RA-B-0.5	500	—	10,000	150F	UL, CSA
TRF600-160	500	—	10,000	160F	UL, CSA, TÜV
TRF600-160-2	—	600	3,000	160F	UL, CSA, TÜV
TRF600-250	500	—	10,000	250F	UL, CSA, TÜV
TRF600-400	500	—	10,000	400F	UL, CSA
Surface-mount† — 600V_{AC}					
TSM600/TSM600					
TS600-170F-2	—	300	900	T20	UL, CSA
TS600-200F-RA-2	—	300	900	T20	UL, CSA
TS600-400F-2	—	300	900	T40	UL, CSA
TSM600-250F-2	—	200	1,000	TSM600	UL, CSA
TSM600-250F-RA-2	—	200	1,000	TSM600	UL, CSA
TSM600-400F-2	—	200	1,000	TSM600	UL

 * 250V_{AC} interrupt products are designed to help equipment pass ITU K.20, K.21 and K.45 recommendations and Telcordia GR-1089 Port Type 2 and 4 requirements.

 † 600V_{AC} interrupt products are designed to help equipment pass UL60950, TIA-968-A and GR1089 Port Type 1, 3 and 5 requirements.

Agency Recognition for PolySwitch Telecommunications and Networking Devices

UL	File # E74889	
CSA	File # 78165C	
TÜV	Per IEC60730-1	Certificate # for individual products available upon request.

Table T7 Recommended Pad Layouts for Surface-mount PolySwitch Telecommunications and Networking Devices in Millimeters (Inches) Nominal

Device	A	B	C	D	E	F	G	Figure
TS250 (All)	4.60 (0.180)	1.80 (0.070)	6.10 (0.240)	—	—	—	—	T18
TSV250 (All)	2.29 (0.090)	2.41 (0.095)	6.35 (0.250)	3.43 (0.135)	—	—	—	T19
TSL250 (All)	3.60 (0.140)	1.80 (0.070)	5.50 (0.220)	—	—	—	—	T18
TS600 (All)	10.42 (0.410)	3.30 (0.130)	3.35 (0.132)	—	—	—	—	T18
TSM600 (All)	5.20 (0.205)	17.80 (0.701)	5.54 (0.218)	6.75 (0.266)	2.08 (0.082)	3.12 (0.123)	8.39 (0.331)	T20

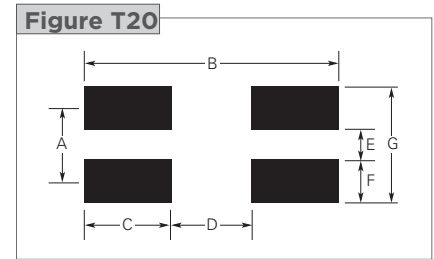
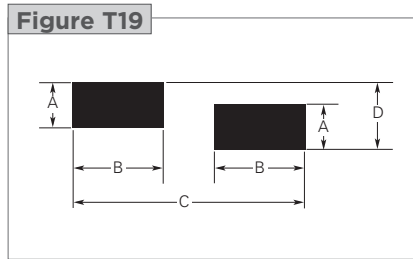

Solder Reflow and Rework Recommendations for PolySwitch Telecommunications Surface-Mount Devices

Profile Feature	Pb-Free Assembly
Average ramp up rate (T_{sMAX} to T_p)	3°C/s max
Preheat	
• Temperature min (T_{sMIN})	150°C
• Temperature max (T_{sMAX})	200°C
• Time (t_{sMIN} to t_{sMAX})	60-180 s
Time maintained above:	
• Temperature (T_L)	217°C
• Time (t_L)	60-150 s
Peak/Classification temperature (T_p)	260°C
Time within 5°C of actual peak temperature	
Time (t_p)	20-40 s
Ramp down rate	6°C/s max
Time 25°C to peak temperature	8min max

Note: All temperatures refer to topside of the package, measured on the package body surface.

Solder Reflow

- Recommended reflow method: IR, vapor phase oven, hot air oven.
- Surface-mount devices are not intended to be wave soldered to the bottom side of the board.
- Recommended maximum paste thickness of 0.25mm (0.010in).
- Devices can be cleaned using standard industry methods and solvents.

Rework

- If a device is removed from the board, it should be discarded and replaced with a new device.

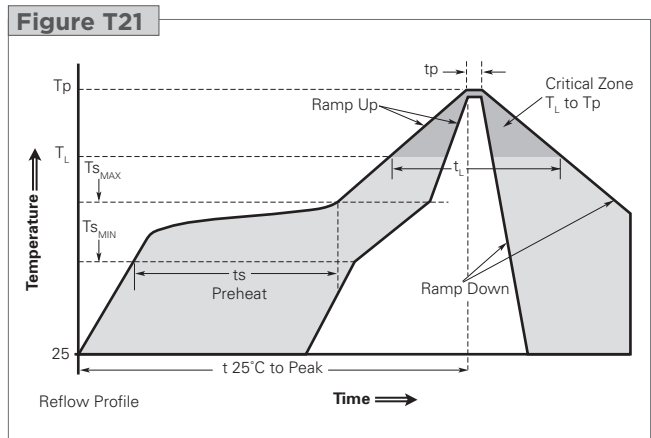

Wave Soldering and Rework Recommendations for PolySwitch Telecommunications Radial-Leaded Devices

Recommended Wave Soldering

- Soldering temperature profile
Temperature characteristic at component terminal with dual wave soldering

Rework

- If a device is removed from the board, it should be discarded and replaced with a new device

Figure T22

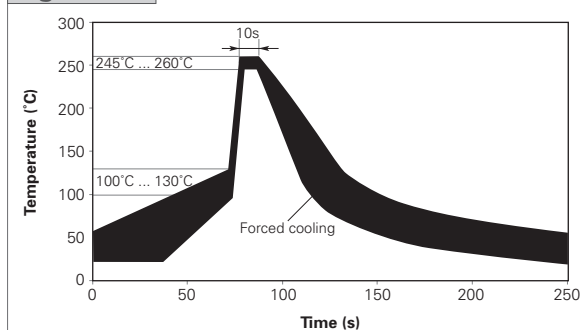

Table T8 TRF250/TRF600 Tape and Reel Specifications for PolySwitch Telecommunications and Networking Device

TRF250/TRF600 devices are available in tape and reel packaging per EIA 468-B standard. See Figures T23 and T24 for details.

Dimension Description	EIA Mark	IEC Mark	Dimension (mm)	Tolerance
Carrier Tape Width	W	W	18	-0.5/+1.0
Hold Down Tape Width	W ₄	W ₀	5	Min
Top Distance between Tape Edges	W ₆	W ₂	3	Max
Sprocket Hole Position	W ₅	W ₁	9	-0.5/+0.75
Sprocket Hole Diameter	D ₀	D ₀	4	±0.2
Abcissa to Plane (Straight Lead)	H	H	18.5	±3.0
Abcissa to Plane (Kinked Lead)*	H ₀	H ₀	16	-0.5/+0.6
Abcissa to Top	H ₁	H ₁	32.2	Max
Overall Width with Lead Protrusion	—	C ₁	43.2	Max
Overall Width without Lead Protrusion	—	C ₂	42.5	Max
Lead Protrusion	L ₁	I ₁	1.0	Max
Protrusion of Cut-out	L	L	11	Max
Protrusion beyond Hold Down Tape	I ₂	I ₂	Not Specified	—
Sprocket Hole Pitch	P ₀	P ₀	12.7	±0.3
Device Pitch (TRF250 and TRF600-150)	—	—	12.7	—
Device Pitch (TRF600-160 - TRF600-400)	—	—	25.4	—
Pitch Tolerance	—	—	20 Consecutive	±1
Tape Thickness	t	t	0.9	Max
Tape Thickness with Splice*	t ₁	—	2.0	Max
Splice Sprocket Hole Alignment	—	—	0	±0.3
Body Lateral Deviation	Δh	Δh	0	±1.0
Body Tape Plane Deviation	Δp	Δp	0	±1.3
Lead Spacing Plane Deviation	ΔP ₁	P ₁	0	±0.7
Lead Spacing*	F	F	5.08	±0.6
Reel Width	w ₂	w	56	Max
Reel Diameter	a	d	370	Max
Space between Flanges Less Device	w ₁	—	4.75	±3.25
Arbor Hole Diameter	c	f	26	±12.0
Core Diameter	n	h	80	Max
Box	—	—	56/372/372	Max
Consecutive Missing Pieces*	—	—	3 Max	—
Empty Places per Reel*	—	—	Not Specified	—

* Differs from EIA specification.

Figure T23 EIA Referenced Taped Component Dimensions for PolySwitch Telecommunications Radial-Leaded Devices



Figure T24 Reel Dimensions for PolySwitch Telecommunications Radial-Leaded Devices

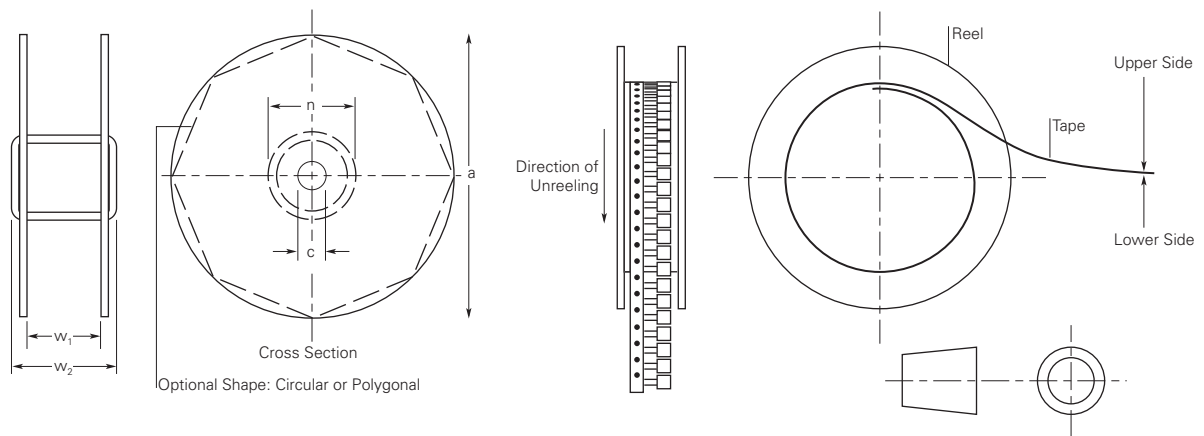

Table T9 TS Tape and Reel Specifications for PolySwitch Telecommunications and Networking Devices

TS devices are packaged per EIA 481 and EIA 481-2 standards. See Figures T25 and T26 for details.

TS250/TSL250/TSV250

Dimension Description	EIA Mark	TS250		TSV250		TSL250	
		Dimension (mm)	Tolerance (mm)	Dimension (mm)	Tolerance (mm)	Dimension (mm)	Tolerance (mm)
Carrier Tape Width	W	16	±0.30	16.0	±0.30	16	±0.30
Sprocket Hole Pitch	P ₀	4.0	±0.10	4.0	±0.10	4.0	±0.10
	P ₁	12.0	±0.10	8.0	±0.10	8.0	±0.10
	P ₂	2.0	±0.10	2.0	±0.10	2.0	±0.10
	A ₀	6.9	±0.23	5.5	±0.10	5.5	±0.10
	B ₀	9.6	±0.15	6.2	±0.10	7.9	±0.10
	B ₁ max	12.1	—	8.0	—	9.2	—
Sprocket Hole Diameter	D ₀	1.5	-0/+0.1	1.55	±0.05	1.55	±0.05
	F	7.5	±0.10	7.5	±0.10	7.5	±0.10
	E ₁	1.75	±0.10	1.75	±0.10	1.75	±0.10
	E ₂ min	14.25	—	—	—	—	—
Tape Thickness	T max	0.4	—	0.45	—	0.35	—
Tape Thickness With	T ₁ max	0.1	—	0.1	—	0.1	—
Splice Cover Tape Thickness	K ₀	3.4	±0.15	7.0	±0.10	3.70	±0.10
	Leader min	300	—	390	—	390	—
	Trailer min	300	—	160	—	160	—

Reel Dimensions

Reel Diameter	A max	340	—	340	—	340	—
Core Diameter	N min	50	—	50	—	50	—
Space between Flanges-less Device	W ₁	16.4	-0/+2.0	16.4	-0/+2.0	16.4	-0/+2.0
Reel Width	W ₂ max	22.4	—	22.4	—	22.4	—

TS600

Dimension Description	EIA Mark	Dimension (mm)	Tolerance
Carrier Tape Width	W	32	±0.3
Sprocket Hole Pitch	P ₀	4.0	±0.1
	P ₁	16	±0.1
	P ₂	2.0	±0.1
	A ₀	10	±0.1
	B ₀	19.2	±0.1
	B ₁ max	21.6	—
Sprocket Hole Diameter	D ₀	1.5	-0/+1.0
	F	14.2	±0.1
	E ₁	1.75	±0.1
	E ₂ min	28.4	±0.1
Tape Thickness	T max	0.50	±0.5
Tape Thickness with Splice	T ₁ max	0.1	—
	K ₀	13.2	±0.1
	Leader min	390	—
	Trailer min	160	—

Reel Dimensions

Reel Diameter	A max	360	—
Core Diameter	N min	50	—
Space between Flanges-less Device	W ₁	32.4	-0/+2.0
Reel Width	W ₂ max	40	—

Table T9 TS Tape and Reel Specifications for PolySwitch Telecommunications and Networking Devices Cont'd

TS devices are packaged per EIA 481 and EIA 481-2 standards. See Figures T25 and T26 for details.

TSM600

Dimension Description	EIA Mark	Dimension (mm)	Tolerance
Carrier Tape Width	W	32	±0.3
Sprocket Hole Pitch	P ₀	4.0	±0.1
	P ₁	24	±0.1
	P ₂	2.0	±0.1
	A ₀	11.2	±0.1
	B ₀	17.8	±0.1
	B ₁ max	23.45	
Sprocket Hole Diameter	D	1.5	-0/+1.0
	F	14.2	±0.1
	E ₁	1.74	±0.1
	E ₂ max	28.4	±0.1
Tape Thickness	T max	0.5	±0.5
Tape Thickness with Splice	T ₁ max	0.1	
	K ₀	11.9	±0.1
	Leader min	390	
	Trailer min	160	

Reel Dimensions

Reel Diameter	A max	360	
Core Diameter	N min	50	
Space between Flanges-less Device	W ₁	32.4	-0/+2.0
Reel Width	W ₂ max	40	

Figure T25 EIA Referenced Taped Component Dimensions for PolySwitch Telecommunications and Networking Devices



Figure T26 EIA Referenced Reel Dimensions for PolySwitch Telecommunications and Networking Devices



PolySwitch Telecommunications and Networking Resistance-Sorted and Resistance-Matched Devices

Most TCF, TRF and TS devices are available in resistance-sorted and/or resistance-matched versions.

Resistance-sorted Devices

Resistance-sorted devices (part number suffix “Rx”, where x = 1, 2, A, B, C, F, etc.) are supplied with resistance values that are within specified segments of the device’s full range of resistance.

Feature

- Narrow resistance range.

Benefits

- Can help provide greater flexibility for design engineers.
- Lower resistance devices can help provide increased loop length on line card designs.
- Higher resistance devices may help provide greater protection by offering faster time-to-trip.

Resistance-matched Devices

Resistance-matched devices are supplied such that all parts in one particular package (or reel) are within 0.5Ω of each other (1.0Ω for TRF250-080T devices). Individual matched packages are supplied from the full resistance range of the specified device.

Feature

- Tighter resistance balance between any two parts in a package.

Benefits

- Resistance-matched devices may help reduce the tip-ring resistance differential, reducing the possibility of line imbalance.

Part Numbering System for PolySwitch Radial-Leaded Telecommunications and Networking Devices

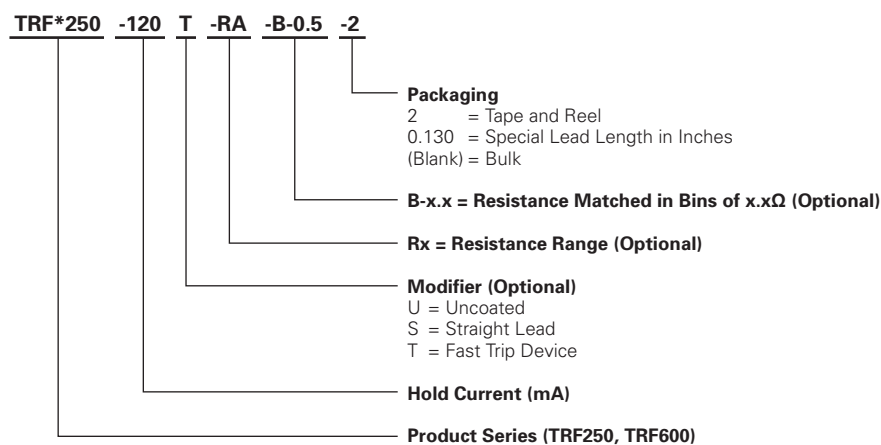

* F = RoHS compliant, ELV compliant

Part Numbering System for PolySwitch Surface-mount Telecommunications and Networking Devices

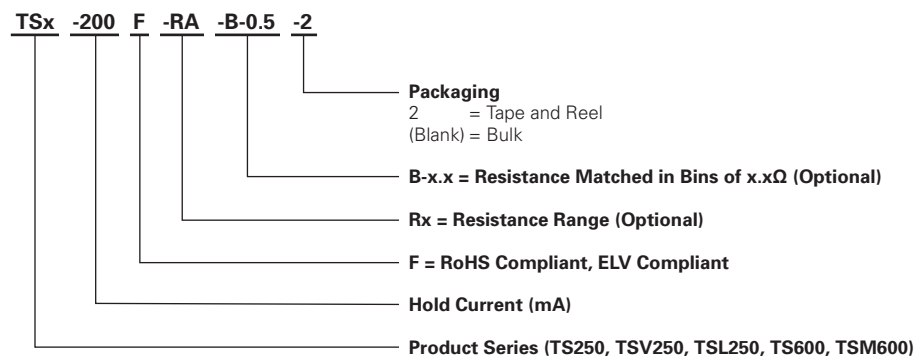

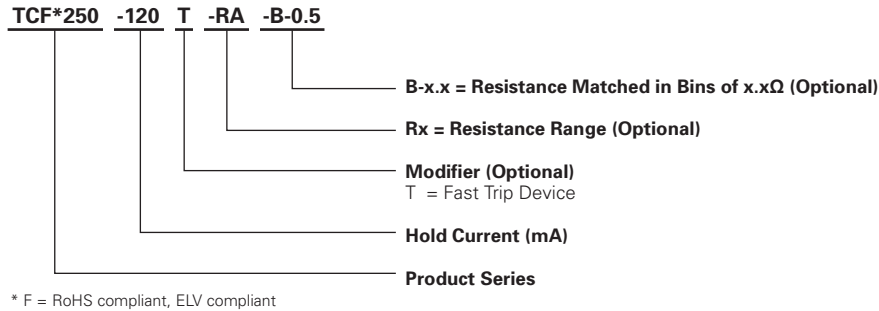

Warning :

- Users should independently evaluate the suitability of and test each product selected for their own application.
- Operation beyond the maximum ratings or improper use may result in device damage and possible electrical arcing and flame.
- These devices are intended for protection against damage caused by occasional overcurrent or overtemperature fault conditions and should not be used when repeated fault conditions or prolonged trip events are anticipated.
- Contamination of the PPTC material with certain silicone-based oils or some aggressive solvents can adversely impact the performance of the devices.
- Device performance can be impacted negatively if devices are handled in a manner inconsistent with recommended electronic, thermal and mechanical procedures for electronic components.
- PPTC devices are not recommended for installation in applications where the device is constrained such that its PTC properties are inhibited, for example in rigid potting materials or in rigid housings, which lack adequate clearance to accommodate device expansion.
- Operation in circuits with a large inductance can generate a circuit voltage (Ldi/dt) above the rated voltage of the device.